

क्षेत्रीय जैवप्रौद्योगिकी केन्द्र
Regional Centre for Biotechnology

राष्ट्रीय महत्ता की संस्था

An institution of National Importance

(यूनेस्को के तत्वावधान में जैव प्रौद्योगिकी विभाग, भारत सरकार द्वारा स्थापित)
(Established by the Dept of Biotechnology, Govt of India under the auspices of UNESCO)

No. RCB/MIsc/22-23

Dated: 23.06.2022

Observations for Purchase of Drosophila Activity Monitor

We are in the process of purchase of **Drosophila Activity Monitor** from M/s TriKinetics Inc. on Proprietary basis.

Any observations regarding the same may be emailed to purchase@rcb.res.in or submitted by speed post/courier to the under mentioned address on or before **03.07.2022**:

Purchase Division
Regional Center for Biotechnology
NCR Biotech Science Cluster
3rd Mile Stone, Gurugram-Faridabad Expressway
Faridabad, Haryana-121001

सुदीप
24/6/22
Controller of Administration

डॉ. सुदीप भार, प्रशासन नियंत्रक
क्षेत्रीय जैवप्रौद्योगिकी केन्द्र
फरीदाबाद, हरियाणा

04

TECHNICAL SPECIFICATIONS FOR DROSOPHILA ACTIVITY MONITORING SET-UP AND ACCESSORIES (COUNT 1).

| Item# | Description of the parts | Quantity |
|-------|---|----------|
| 1 | Drosophila Activity Monitor with 32 channels for 5mm diameter tubes with CAB2 cables | 1 |
| 2 | Drosophila Activity Monitoring system with 4 channels for each of 32 tubes (5mm each) | 1 |
| 3 | Power Supply Interface Unit (with PS9-1 power supply, line cord, USB cable, CAB10 cable with coupler) | 2 |
| 4 | Monitoring tubes (Pyrex Glass 5mm diameter, 65mm length) (Set of 100) | 1 |
| 5 | Monitoring tubes (5mm diameter, 80mm length Pyrex Glass) (Set of 100) | 1 |
| 6 | Vinyl Tube Caps fits the pyrex glass tubes black color (Set of 100) | 1 |
| 7 | Molded PVC Caps for the pyrex glass tubes black color (Set of 100) | 1 |
| 8 | LC4 Light Controller (for Lighting control)- 4 channels at 3A, 240VAC each includes CAB10 cable and AC line cord | 1 |
| 9 | VMP mounting plate for mounting the activity monitors that fits the vortexer and holds upto 4 Drosophila activity monitors. | 1 |

Pa

Greetanjali Chawla
ceoghny

DAMSystem Product Price List

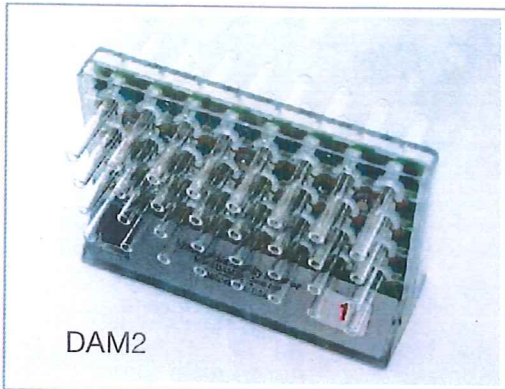

DAM2

DAM2 Drosophila Activity Monitor

- 32 tubes, 5mm diameter
- Dual consolidated IR beams per tube
- Output data type: Counts
- Available models
 - DAM2 for 5mm tube = \$485.

Item 1

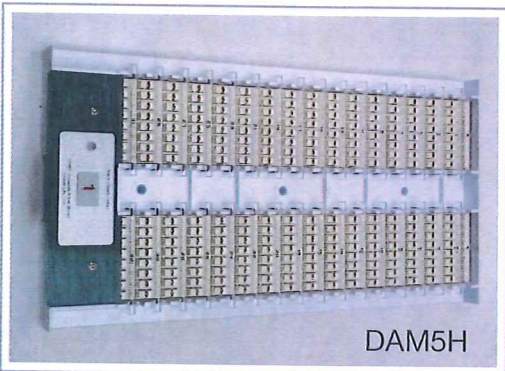

DAM5H

DAM5H Drosophila Activity Monitor

- 32 tubes, 5mm diameter
- 4 or 15 independent IR beams per tube
- Output data types: Counts, Moves, Dwell, Latency, Position, Rest
- Built-in clips hold tubes securely
- Available models
 - DAM5H = \$1,225. (15 beams per tube)
 - DAM5H-4 = \$925. (4 beams per tube)

Item 2



LAM25H

LAM10/16/25 Locomotor Activity Monitor

- 32 tubes, 10, 16, or 25mm diameter
- 3 or 9 (high res) consolidated IR beams per tube
- Available models
 - LAM10, LAM16, LAM25 = \$925.
 - LAM10H, LAM16H, LAM25H = \$1,225. (high res)
- LAMVTS Vertical Tube Support plate = \$100.

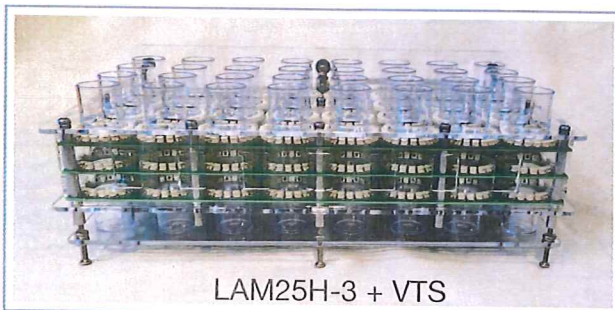

LAM25H-3 + VTS

LAM25H-3 Locomotor Monitor

- 3-board stack monitors 3 axial positions per tube for added fidelity.
- Available models
 - LAM25H-3 = \$3200. 17.5mm bd sep
 - LAM25H-3/XS = \$3350. 27mm sep

TRIKINETICS

Greetanjali Chawla

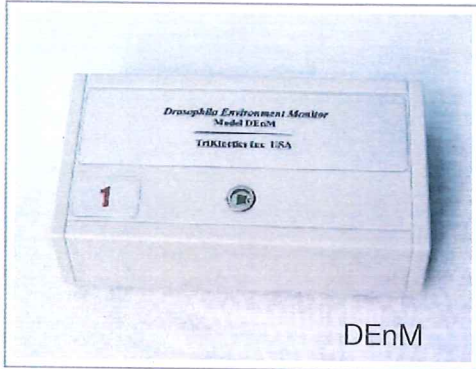

DEnM

DEnM Drosophila Environment Monitor

- Measures incubator conditions alongside activity data for archival record.
- Precision measurements verify chamber setpoints
- Temperature: 0-70C, +/- 0.1 degC
- Relative Humidity: 0-95%, +/- 2%
- Ambient Light: 0-65K lux, +/- 5%
- Available models
 - DEnM = \$450. (Temp, RH, Light)

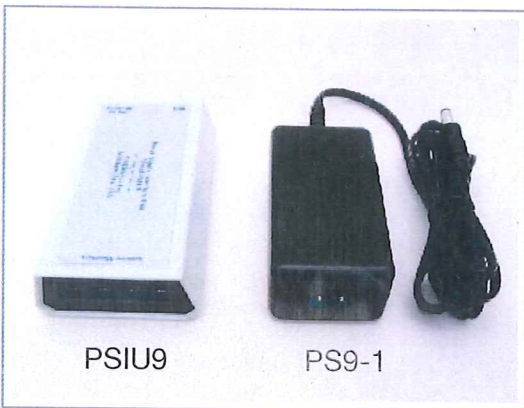

PSIU9

PS9-1

PSIU9 Power Supply Interface Unit

- Connects data collection computer to activity monitors. One required per system.
- Includes PS9-1 AC power supply, AC line cord, USB cable, and 10' extension data cable with coupler
- Available models
 - PSIU9 = \$350. (includes PS9-1)
 - PS9-1 Power supply = \$40. (9VDC, 1A)

Item 3

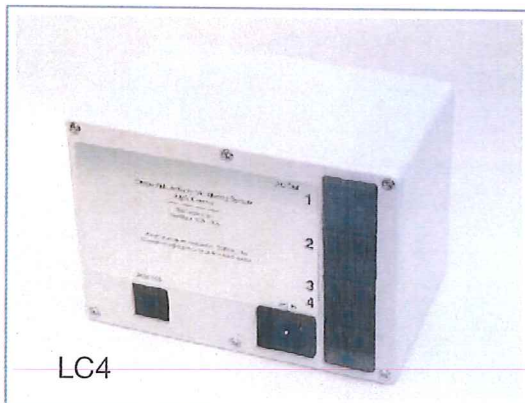

LC4

LC4 Light Controller

- On/off switching of 4 AC outlets
- Pulse duration from 0.1 second to 99 hours
- Single, periodic, or random pulse repetition
- Incubator lighting control
- Vortexer pulsing for sleep deprivation
- 3A, 240VAC max for each outlet, 50/60 hz
- Available models
 - LC4 = \$800.

Item 4

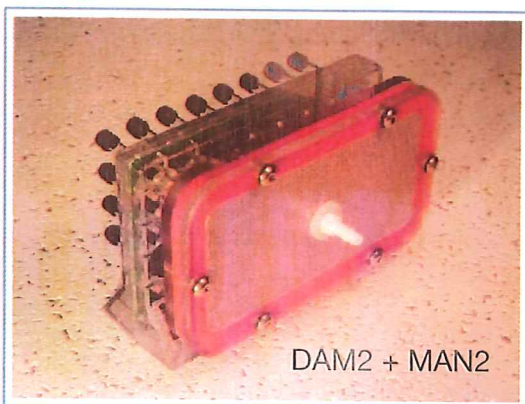

DAM2 + MAN2

MAN2 Gas Distribution Manifold

- Facilitates gas flow thru DAM2 5mm tubes
- Tubes snap into manifold via gasket seal
- Exit holes in plastic tubes (optional)
- Disassembly for cleaning
- Available models
 - MAN2 for 5mm tube = \$400.
 - PPT5x80D1C (50) = \$50. (drilled PC tubes, 1 x 0.75mm hole at tube center for gas vent)

Geetanjali Chawla

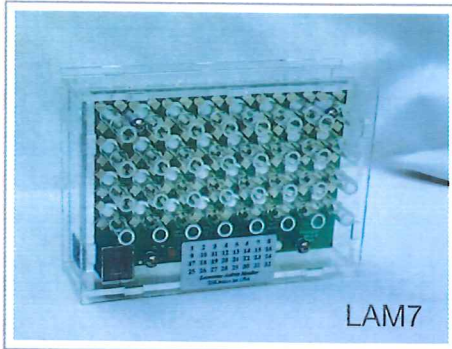

LAM7 Locomotor Activity Monitor

- 32 tubes, 7mm diameter
- Dual consolidated IR beams per tube
- Output data type: Counts
- Available models
 - LAM7 for 7mm tube = \$600.

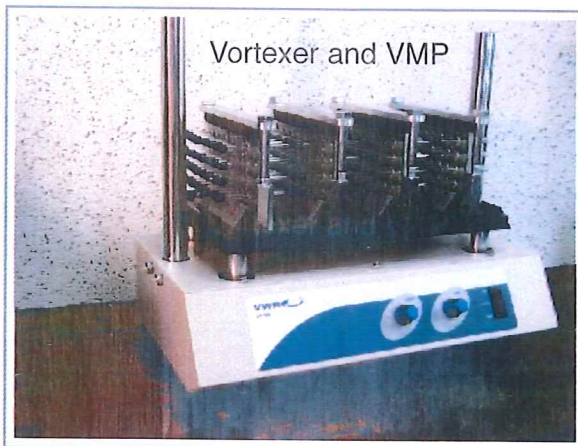

Vortexer Mounting Plate

- Fits Troemner 945007/945008 vortexer
- Securely holds activity monitors during shake cycle
- Compatible with LC4 Light Controller for precision computerized sleep deprivation
- Includes all necessary hardware

Mounting Plates

- VMP = \$575. (holds 4 DAM2 monitors)
- VMP-UD = \$250. (upper deck for VMP)

Item 5

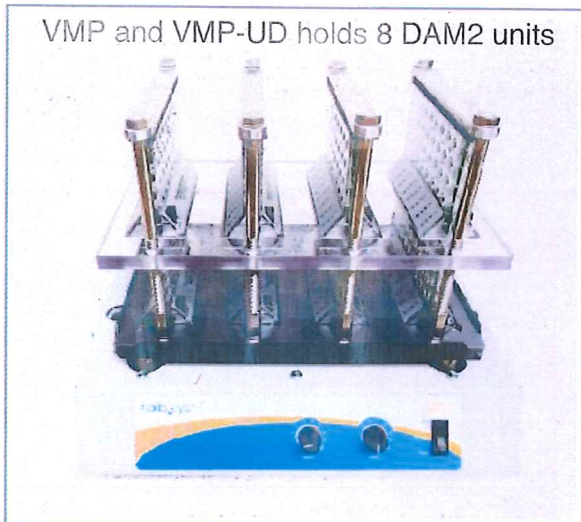

Troemner vortexer with VMP Mounting Plate installed

- TVOR-120 = \$3,000. (120V = 945007)
- TVOR-230 = \$3,000. (230V = 945008)

Greetanjali Chawla

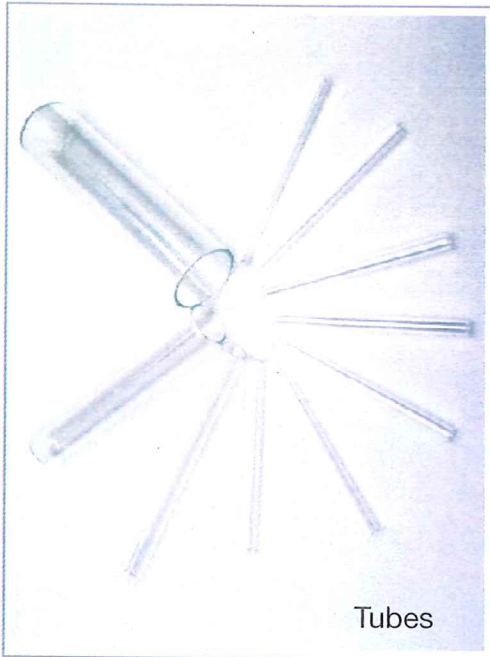

Monitor Tubes (outside diameter x length, mm)

- PGT5x65 Pyrex Glass (100) = \$70.
- PPT5x65 Polycarbonate (100) = \$15.
PPT5x65 Polycarbonate (1000) = \$120.
PPT5x65 Polycarbonate (7500) = \$675.
- PGT5x80 Pyrex Glass (100) = \$90.
- PPT5x80 Polycarbonate (100) = \$16.
- PGT7x65 Pyrex Glass (100) = \$100.
- PGT10x100 Pyrex Glass (100) = \$125.
- PGT16x100 Pyrex Glass (43) = \$65.
- PGT25x125 Pyrex Glass (36) = \$95.

Tubes are open on both ends; glass are fire glazed.
All may be autoclaved.

*Item 6
and
Item 7*



Tube Caps

- CAP5-Black (100) = \$15. (fits 5mm tube)
CAP5-Black (1000) = \$125.
CAP5-Black (5000) = \$500.
- CAP5-Yellow (100) = \$30.
- CAP7-Black (100) = \$17.
- CAP10-Black (100) = \$20.
- CAP16-Black (100) = \$25.
- CAP25-Black (100) = \$30.

Black caps are soft vinyl, yellow is harder PVC.

*Item 8
Item 9*

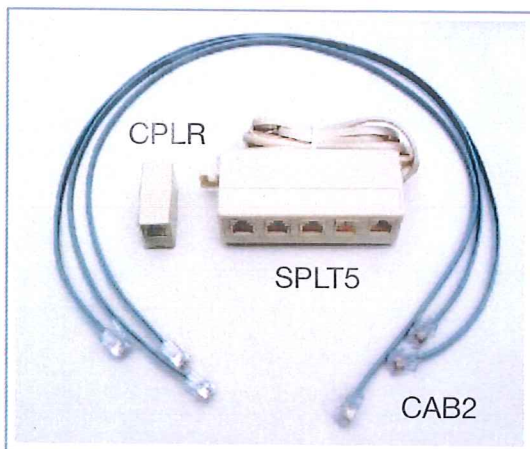

Cables and Connectors

- SPLT5 5-way splitter = \$10.
- CPLR Coupler = \$5.
- CAB2 2' (61cm) monitor cable = \$5.
- CAB10 10' (305 cm) extension cable = \$8.

*with
Item 1
and 2*

Ordering Notes

| | |
|---------------------|---|
| How to order | Send a Purchase Order by email to sales@trikinetics.com , including item list, shipping address, and email address for invoice submission. Credit card payment is accepted with an added 3.5% (domestic) or 5.0% (foreign) PayPal handling fee. A PayPal account is not required. |
| Prices | In fairness to everyone, prices for products listed herein are applicable to all purchases from all customers, whether new or old, near or far, great or small. Dealers, agents, and resellers are hereby authorized to purchase these same products on a non-exclusive basis, but no discounts are available. |
| Basic System | A basic system will include the PSIU9, one or more activity monitors, and a customer-supplied Macintosh or Windows PC with USB port for data collection and storage. |
| Tubes and Caps | Unless otherwise noted, monitors do not include tubes or caps, which may be ordered separately. |
| Wiring Accessories | All systems are shipped with appropriate DAMSystem network wiring accessories, including cables, couplers, and 5-way splitters. Monitor cables are 50cm (2') long and extension cables are 3m (10') long unless otherwise specified. |
| Monitor Numbers | All units are identified by a unique numeric address in the range 1:120 which must be specified at the time of order. Addresses should not be duplicated within a system, and will be assigned consecutively from #1 unless otherwise specified. |
| Software | The DAMSystem data acquisition software package and PSIU9 USB driver are available for download at no charge from the TriKinetics web site, www.trikinetics.com . |
| Foreign Orders | Overseas shipment is available for any item. Foreign customers should be advised that VAT or other import duty will likely be assessed on arrival, and may slow delivery if preparations are not made in advance. |
| Warranty and Repair | Defective units will be repaired at no charge. |
| Specifications | All specifications are nominal, and subject to change without notice to improve product reliability or performance. No liability is assumed for loss of data or consequential damages, and all trademarks are the property of their respective owners. |
| Acknowledgments | These units were developed with the continuing assistance and support of scientists in many laboratories around the world, and this support is gratefully acknowledged. We are especially indebted to Prof. Michael Rosbash and Prof. Jeffrey Hall at Brandeis University for their cooperation and assistance in the early days. |
| Contact | TriKinetics Inc Waltham, MA USA sales@trikinetics.com ©1986-2021 |

TRIKINETICS INC

56 EMERSON ROAD
WALTHAM, MA 02451 USA

www.trikinetics.com

May 26, 2022

Dr. Geetanjali Chawla 91-129-2848860
RNA Biology Laboratory
Regional Centre for Biotechnology
NCR Biotech Science Cluster
Faridabad, Haryana- 121 001
India

Fall clause, Authorization and Proprietary
certificate

Re: Proprietary Certificate

To whom it may concern,

This will certify that the following products are designed and manufactured by TriKinetics Inc in Waltham, Massachusetts USA, and to our knowledge are unavailable elsewhere:

DAM2 Drosophila Activity Monitor
DAM5H Drosophila Activity Monitor
PSIU9 Power Supply Interface Unit
LC4 Light Controller

Associated hardware, tubes, caps, and cables

Prices quoted are according to the published price list, and will not be offered for less to anyone, anywhere.

Sincerely,



R Mark Spencer, President
mspencer@trikinetics.com

Geetanjali Chawla